



# Design Guide

THE DESIGN OF PRODUCTS TO BE  
HOT-DIP GALVANIZED AFTER FABRICATION



© 2018 American Galvanizers Association. The material provided herein has been developed to provide accurate and authoritative information about after-fabrication hot-dip galvanized steel. This material provides general information only and is not intended as a substitute for competent professional examination and verification as to suitability and applicability. The information provided herein is not intended as a representation or warranty on the part of the AGA. Anyone making use of this information assumes all liability arising from such use.



## TABLE OF CONTENTS

<b>02</b>	<b>INTRODUCTION</b>
<b>02</b>	<b>COMMUNICATION IS KEY</b>
<b>02</b>	<b>MATERIALS SUITABLE FOR GALVANIZING</b>
<b>04</b>	<b>COMBINING DIFFERENT MATERIALS AND SURFACES</b>
<b>05</b>	<b>SIZE AND SHAPE</b>
<b>05</b>	<b>PROCESS TEMPERATURE &amp; HEAT</b>
	Mechanical Properties of Galvanized Steel
	Strain-Age Embrittlement
	Hydrogen Embrittlement
	Cut Steel Edges
<b>07</b>	<b>MINIMIZING DISTORTION</b>
<b>10</b>	<b>ALLOWING FOR PROPER DRAINAGE</b>
<b>10</b>	<b>VENTING TUBULAR FABRICATIONS &amp; HOLLOW STRUCTURALS</b>
	Handrail
	Rectangular Tube Truss
	Pipe Truss
	Pipe Columns, Pipe Girders, Street Light & Transmission Poles
	Box Sections
	Tapered Signal Arm
<b>15</b>	<b>PROPER VENTING &amp; DRAINAGE OF ENCLOSED &amp; SEMI-ENCLOSED FABRICATIONS</b>
<b>17</b>	<b>PRECAUTIONS FOR OVERLAPPING &amp; CONTACTING SURFACES</b>
<b>18</b>	<b>WELDING PROCEDURES &amp; WELDING FLUX REMOVAL</b>
<b>18</b>	<b>THREADED PARTS</b>
<b>20</b>	<b>MOVING PARTS</b>
<b>20</b>	<b>ADDITIONAL DESIGN CONSIDERATIONS</b>
	Masking
	Marking for Identification
<b>22</b>	<b>POST GALVANIZING CONSIDERATIONS</b>
	Storage
	Cleaning Galvanized Steel
<b>23</b>	<b>PERFORMANCE IN SERVICE ENVIRONMENT</b>
<b>23</b>	<b>SUMMARY</b>
<b>24</b>	<b>RELATED SPECIFICATIONS</b>

## INTRODUCTION

As the world continues to evolve, it is important to construct a better environment for the future. Throughout the world, hot-dip galvanized steel has been used to provide unmatched protection against the ravages of corrosion. New technologies and creative chemistry continue to advance the galvanizing process – a mainstay in North American industry since the 1870s.

The use of hot-dip galvanized steel continues to grow not only in traditional, existing markets, but new and emerging ones as well. From bolts to sturdy bridges traversing rushing rivers; artful sculptures and building facades to utilitarian guardrail and utility poles, hot-dip galvanizing is an important part of everyday life. Once used solely as a means of corrosion protection, hot-dip galvanizing is now specified for many other reasons such as lower cost (initially and over the life-cycle), durability, longevity, versatility, sustainability, and aesthetics.

There are certain practices for all materials and coatings which yield better quality finished products. In order to meet the expectations and demands of many different markets, it is important to be cognizant of the best design practices when planning to galvanize steel. Often no or only minor adjustments to the design are necessary, and worth the extra time and effort up front to alleviate certain future headaches related to the utilization of other coating systems.

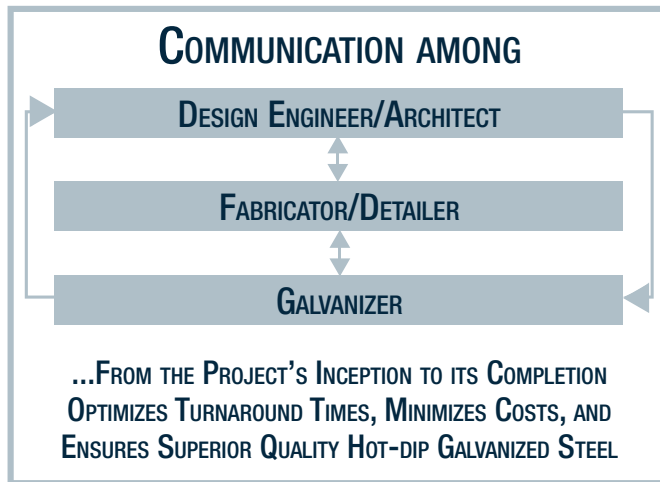

## COMMUNICATION IS KEY

Corrosion protection begins at the drawing board because all corrosion protection systems require certain design details and proper planning to ensure the highest quality coating. So regardless of the protection method specified, it must be factored into the product's design. For hot-dip galvanizing, a total immersion process in molten zinc, the design engineer will want to ensure all pieces are fabricated suitably for the process.

Most design principles necessary for success throughout the galvanizing process are easily and readily followed, and in most cases, ensure maximum corrosion protection. Incorporating these design practices along with those listed in ASTM A385 *Practice for Providing High Quality Zinc Coatings (Hot-Dip)*, will not only produce optimum quality galvanized coatings, but also help reduce costs and improve turnaround times.

One key to providing the best design for the hot-dip galvanizing process is communication between the architect, engineer, fabricator and galvanizer. Opening the lines of communication early in the design process can eliminate potential costly pitfalls later in the process. A few discussion topics good to cover while the project is being designed include:

- Steel Chemistry & Surface Condition
- Size & Shape
- Process Temperature/Heat
- Venting & Drainage
- Welding
- Threaded Parts/Connections
- Post Galvanizing Design/Use

Understanding these aspects of the galvanizing process and how they can affect the coating and finished product's outcome will help ensure everyone's expectations are met.

## MATERIALS SUITABLE FOR GALVANIZING

Most iron-containing (ferrous) materials are suitable for hot-dip galvanizing. Plain carbon steel (under 170 ksi or 1,200 MPa) and low alloy materials, hot-rolled steel, cold-rolled steel, cast steel, ductile iron, cast iron, castings, stainless steel, and even weathering steel can be and are galvanized for enhanced corrosion protection. However, the material's chemical composition influences the characteristics of the galvanized coating.

During galvanizing, the iron in the steel reacts with the molten zinc to form a series of zinc-iron alloy layers, which are covered by a layer of iron-free zinc. For most hot-rolled steels, the zinc-iron alloy portion of the coating will represent 50-70% of the total coating thickness, with the zinc outer layer accounting for the balance (*Figure 1*).

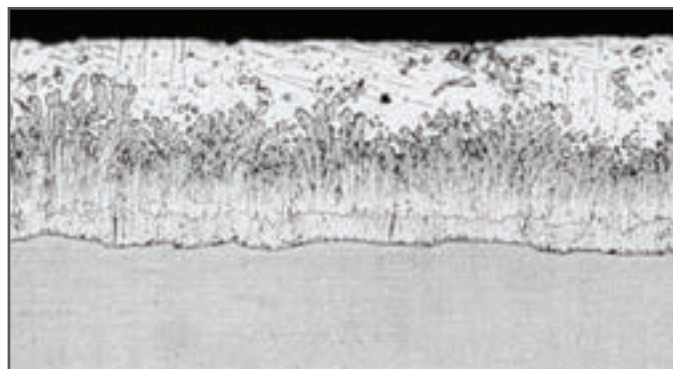

Figure 1: Typical zinc-iron alloy layers



Steel compositions vary depending on strength and service requirements. Trace elements in the steel (silicon, phosphorus) affect the galvanizing process as well as the structure and appearance of the galvanized coating. Steels with silicon or phosphorus levels outside of the recommended ranges are known in the galvanizing industry as highly reactive steel, and may produce a coating composed entirely, or almost entirely, of zinc-iron alloy layers (Figure 2).

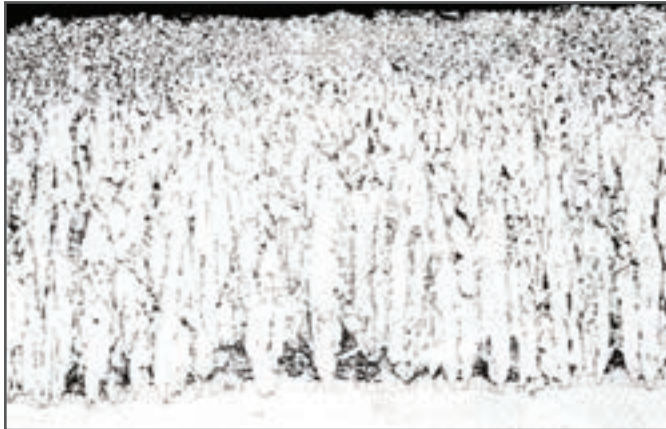

Figure 2: Atypical zinc-iron alloy layers

Atypical coatings produced from reactive steels exhibit different coating characteristics than a typical galvanized coating such as:

- **Appearance:** The atypical galvanized coating may have a matte gray appearance and/or rougher surface due to the absence of the free zinc layer. The free zinc layer present on typical coatings imparts a shinier finish to a galvanized coating.
- **Adherence:** The zinc-iron alloy coating tends to be thicker than a typical galvanized coating. In the rare situation where the coating is excessively thick, there is the possibility of diminished adhesion under external stress (thermal gradients, sharp impact).

Reactive steels are still galvanized on a regular basis, and it is important to note differences in appearance have no effect on the corrosion protection afforded by the galvanized coating. The performance of the coating is based on the thickness of the zinc; therefore, often the duller (and thicker) coatings produced by reactive steels last longer. Furthermore, over time, as galvanized coatings weather, they all develop a uniform matte gray appearance.

It is difficult to provide precise guidance in the area of steel selection without qualifying all steel grades commercially available. However, these guidelines will assist you in selecting steels that provide good galvanized coatings:

- Levels of carbon less than 0.25%, phosphorus less than 0.04%, or manganese less than 1.35% are beneficial
- Silicon levels less than 0.04% or between 0.15% - 0.22% are desirable

Silicon may be present in many steels commonly galvanized even though it is not a part of the steel's controlled composition, because silicon is used in the steel deoxidation process and is found in continuously cast steel. Both silicon and phosphorous act as catalysts during the galvanizing process, resulting in rapid growth of zinc-iron alloy layers.

Even when both elements are individually held to desirable limits, the combined effect between them can still produce an atypical coating of all or mostly zinc-iron alloy layers. When possible, your galvanizer should be advised of the grade of steel selected in order to determine whether specialized galvanizing techniques are suggested.

### CASTINGS

High-quality castings and forged parts are also commonly and successfully galvanized. The galvanized coating finish is strongly influenced by the quality of the casting. As with all steel to be galvanized, cleanliness is very important to achieve completely galvanized cast iron or steel parts. However, conventional processes employed by galvanizers do not adequately clean castings because sand and other surface inclusions are not removed by chemical cleaning. Thorough abrasive cleaning either by grit-blasting or a combination of grit and shot is the preferred and most effective method to remove foundry sand and impurities from the casting. Cleaning is traditionally performed at the foundry before shipment to the galvanizer. Sound, stress-free castings with good surface finishes will produce high-quality galvanized coatings.

### DESIGNING CASTINGS FOR GALVANIZING

- Avoid sharp corners and deep recesses.
- Use large pattern numerals and generous radii to facilitate abrasive cleaning.
- Specify uniform wall sections. Non-uniform wall thickness in certain casting designs may lead to distortion and/or cracking.
- Cracking results from stress developed as the temperature of the casting is increased during galvanizing. Uniform wall sections and a balanced design lowers stress.



Bare spots due to embedded sand not removed from casting prior to hot-dip galvanizing



## COMBINING DIFFERENT MATERIALS & SURFACES

Varying surface conditions, different fabrication methods, or ferrous metals with special chemistries, when combined, make it difficult to produce coatings with uniform appearance. These materials require different parameters for pickling (immersion time, solution concentrations, temperatures) and galvanizing (bath temperatures, immersion time) which contribute to varied appearances. Different parameters are required for:

- Coatings such as paint, lacquer, etc. on the steel
- Excessively rusted surfaces
- Machined surfaces
- Cast steel
- Malleable iron
- Hot-rolled steel
- Cold-rolled steel
- Cast iron, especially with sand inclusions
- Pitted surfaces
- Steel containing excess carbon, phosphorus, manganese, or silicon

Many coatings such as paint and lacquer cannot be removed from the steel with the chemical cleaning process used in the galvanizing facility. As clean steel is necessary for the metallurgical reaction to occur in the galvanizing kettle, these surface contaminants need to be removed mechanically prior to sending the fabrication to the galvanizer.

Combining old and new steel, or castings with rolled steel in the same fabrication, should be avoided (*Figure 3*). Where assemblies of cast iron, cast steel, malleable iron, or rolled steel are unavoidable, the entire piece should be thoroughly abrasive-blasted prior to pickling to give the best chance for producing a consistent galvanized coating appearance.

Similarly, excessively rusted, pitted, or forged steels should also not be used in combination with new or machined surfaces because the difference in required pickling time for sulfuric acid pickling baths can cause over-pickling of the new or machined surfaces. Where this combination is unavoidable, a thorough abrasive blast cleaning of the assembly (normally before any machining is done) provides a more uniform galvanized coating.

If abrasive blast cleaning is used to prepare a low silicon steel surface for galvanizing, a thicker coating will be produced. Abrasive cleaning roughens the steel surface, and the increased surface area results in more reactivity with the molten zinc.

The best practice when combining different materials and surfaces is to galvanize separately and assemble after galvanizing. This will help facilitate efficient turnaround times in the process, eliminate over-pickling, and allow the pieces to be matched for appearance.

Whether run through the galvanizing process joined or separately, the differences in appearance on assemblies containing steels with varying surface condition do not affect the corrosion protection. Furthermore, after aging in the environment, all surfaces will exhibit a uniform matte gray appearance.

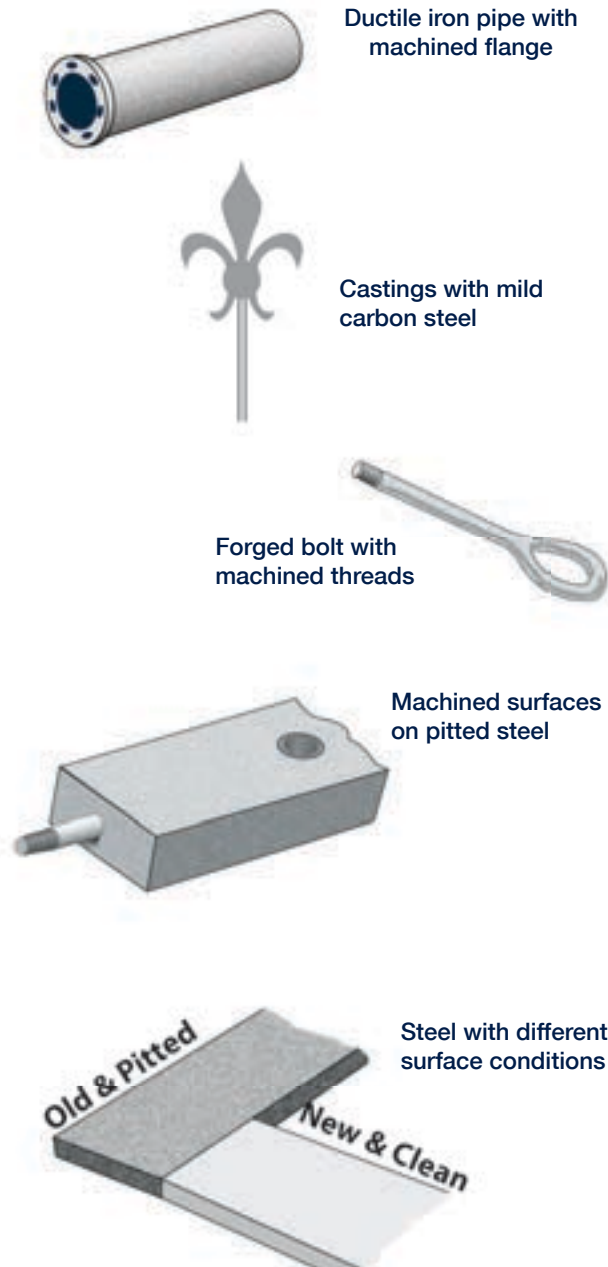

Figure 3: Results will not be consistent with a combination of these types of metals or finishes



## SIZE & SHAPE

Another important consideration during the design process is the size and shape of the fabrication. Because hot-dip galvanizing is a total immersion process, the design must take into consideration the capacity of the galvanizing kettle; therefore, it is wise to verify kettle constraints with your galvanizer early in the design process.

Almost any component can be galvanized by designing and fabricating in modules or sub-units suitable for available galvanizing facilities. The average kettle length in North America is 40 feet (12.19 m), and there are many kettles between 50-60 feet (15.24 m - 18.28 m). Kettle dimensions and contact information for all member galvanizers are available at [www.galvanizeit.org/galvanizers](http://www.galvanizeit.org/galvanizers).

Designing structures in modules or sub-units to accommodate the galvanizing kettle often provides additional savings in manufacturing and assembly because they simplify handling and transportation. The sub-units can be connected after galvanizing by field-welding or bolting. Alternatively, if an item is too large for total immersion in the kettle, but more than half of the item will fit, the piece may be progressively dipped. Progressive dipping is accomplished by dipping each end of the article sequentially to coat the entire item. **Consult your galvanizer before designing a piece for a progressive dip.**



Progressively dipped beam

Considering size and shape, as well as weight, is also important due to material handling techniques used in galvanizing plants. The steel is moved through the process by the use of hoists and overhead cranes. Small items, less than 30 inches (76 cm) in length, are frequently galvanized in perforated baskets. The baskets are then centrifuged or spun to remove excess zinc, delivering smoother coatings. Fasteners, small brackets, and clips typify work handled in baskets.

Large assemblies are usually supported by chain slings or by lifting fixtures. Special jigs and racks are also commonly used to simultaneously galvanize large numbers of similar items.



Hot-dip galvanized fasteners

Providing lifting points where possible will reduce or eliminate chain or wire marks that can be left on an item when no lifting points are present. If no lifting points are provided, any marks, which are usually fully galvanized, can be touched up if desired for aesthetic reasons. It is also good practice to discuss the weight-handling capacity with the galvanizer to ensure capability and/or the best places to put lifting points. In addition to lifting points, large pipe sections, open-top tanks, and similar structures may benefit from temporary bracing to maintain their shape during handling.

## PROCESS TEMPERATURE/HEAT

During the hot-dip galvanizing process, steel is heated to approximately 830 F (443 C) for the galvanizing reaction to occur. Every time steel is heated and cooled, stress is added to the fabrication. Therefore, there are some design considerations to be aware of to help reduce any issues with the heat of the galvanizing process.

## MECHANICAL PROPERTIES OF GALVANIZED STEEL

The hot-dip galvanizing process produces no significant changes in the mechanical properties of the structural steels commonly galvanized throughout the world.

The International Zinc Association (IZA) sponsored a four-year research study of the mechanical properties of 19 structural steels from major industrial countries. The University of Plymouth Enterprise Ltd. investigated the steels, including those conforming to ASTM Specifications A36, A572 Grade 50, and A572 Grade 65.

It was investigated and determined that hot-dip galvanizing produces no significant changes in: steel chemistry, tensile strength, yield strength, bend properties, impact properties, or micro-structure. **Contact AGA for the detailed studies.**



## STRAIN-AGE EMBRITTLEMENT

Many structures and parts are fabricated using cold-rolled steel or cold-working techniques. In some instances, severe cold-working may lead to the steel becoming strain-age embrittled. While cold-working increases the possibility of strain-age embrittlement, it may not be evident until after galvanizing. This occurs because aging is relatively slow at ambient temperatures, but more rapid at the elevated temperature of the galvanizing bath.

Any form of cold-working reduces steel's ductility. Operations such as punching holes, notching, producing fillets of small radii, shearing, or sharp bending (*Figure 4*) may lead to strain-age embrittlement of susceptible steels. Cold-worked steels less than 1/8-inch (3 mm) thick that are subsequently galvanized are unlikely to experience strain-age embrittlement. Since cold-working is the strongest contributing factor to the embrittlement of galvanized steel, the tips (right) are recommended to reduce the incidence of strain-age embrittlement.

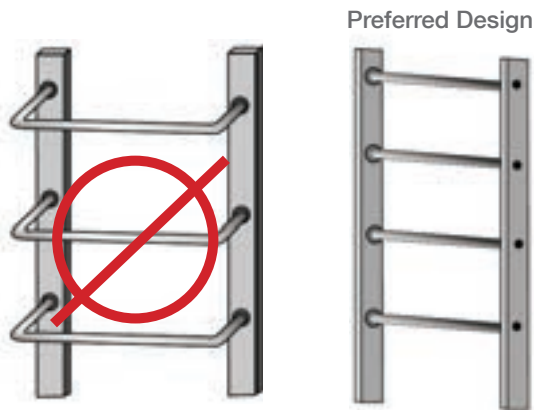

Figure 4: Avoid severe cold-working

ASTM A143, *Safeguarding Against Embrittlement of Hot-Dip Galvanized Structural Steel Products and Procedure for Detecting Embrittlement*, and CSA Specification G164, *Hot-Dip Galvanizing of Irregularly Shaped Articles*, provide guidance on cold-working and stress-relieving procedures. However, it is best to avoid severe cold-working susceptible steels.

If there is concern with possible loss of ductility due to strain-age embrittlement, advise your galvanizer. A sample quantity of the cold-formed items should be galvanized and tested before further commitment.

## TIPS TO REDUCE STRAIN-AGE EMBRITTLEMENT

- Select steels with carbon content below 0.25%.
- Choose steels with low transition temperatures – cold-working raises the ductile-brittle transition temperature and galvanizing (heating) may raise it further.
- Specify aluminum-killed steels; they show less susceptibility to strain-age embrittlement.
- For steels with a carbon content between 0.1% and 0.25%, maintain a bending radius of at least three times (3x) the section thickness. If bending is required to be less than 3x, the material should be stress-relieved at 1100 F (595 C) for one hour per inch (2.5 cm) of section thickness.
- Avoid notches as they increase stress. Notches may be caused during shearing or punching operations. Flame-cutting or sawing is preferred, particularly for heavy sections.
- Drill, rather than punch, holes in material thicker than 3/4-inch (19 mm). If holes are punched, they should be punched undersize and then reamed an additional 1/8-inch (3 mm) overall or drilled to size.
- Material between 1/4 and 3/4-inch (6.5 - 19 mm) thick is not seriously affected by cold punching if the punching is done under good shop practice.
- Material up to 1/4-inch (6.5 mm) thick cold-worked by punching does not need stress-relieving before galvanizing.
- Cut steel sections with edges greater than 5/8-inch (16 mm) thick subject to tensile loads using normal shop procedures. Edges of sections up to 5/8-inch (16 mm) thick may be cut by shearing.
- In critical applications, the steel should be hot-worked above 1200 F (650 C) in accordance with the steel manufacturer's recommendations. Where cold-working cannot be avoided, stress-relieve the part.



Hot-dip galvanizing cold-worked steel is very successful when following suggested guidelines





## HYDROGEN EMBRITTLEMENT

Hydrogen embrittlement is a ductile to brittle change that occurs in certain high-strength steels. Hydrogen embrittlement can occur when the hydrogen released during the pickling process is absorbed by the steel and becomes trapped in the grain boundaries.

Normally, at galvanizing temperatures, hydrogen is expelled from the steel. Although hydrogen embrittlement is uncommon, precautions should be taken to avoid it, particularly if the steel involved has an ultimate tensile strength exceeding 170 ksi (1,200 MPa). If high-strength steels are to be galvanized, cleaning iron oxide should be accomplished by blast cleaning.

## COPE CUTS

Flame cut copes on beams can be extremely sensitive to residual stresses in the steel and the surface of the cut can be rough. Both of these factors can contribute to cracks forming in the cut edges. The potential for cracking can be significantly reduced by thermal conditioning the cut edge. Weld bead should be applied in the highlighted area (*Figure 5*) on both sides of the copes. A simple technique for accomplishing this is to apply a weld bead along the cut edge, thereby reducing residual stresses and avoiding cracking.

There is still a small potential for cracking on these cut edges as well as on the corners of hollow structural steel (HSS) rectangular tubing. The two areas should be visually inspected after galvanizing to detect the presence of any cracks. Any cracks can be repaired and then the coating touched up per ASTM A780, *Practice for Repair of Damaged and Uncoated Areas of Hot-Dip Galvanized Coatings* before the steel is delivered to the job site.

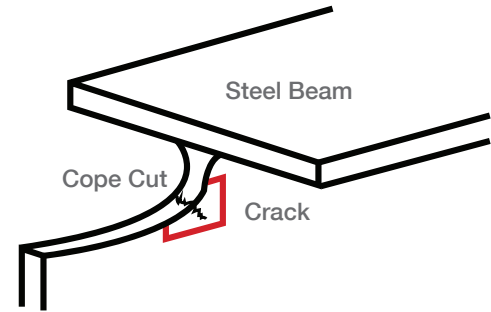

Figure 5: Cope cracks in structural steel beams after galvanizing

## MINIMIZING DISTORTION

Some fabrications are susceptible to distortion at galvanizing temperature as a result of relieving stresses induced during steel production and in subsequent fabricating operations. The potential for warpage/distortion can be greatly reduced through design and production engineering measures to avoid high internal stresses. Communication between the designer, fabricator, and galvanizer early and often during the design process is a good practice to ensure alternative designs can be incorporated where possible to minimize issues.

Guidelines for minimizing distortion and warpage to shape and/or alignment are provided in ASTM A384, *Safeguarding Against Warpage and Distortion During Hot-Dip Galvanizing of Steel Assemblies*. Steel should not be left in the molten zinc bath longer than necessary, as longer immersion time can increase stress between parts in the assembly.



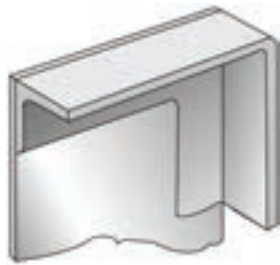

Figure 6: Avoid uneven thickness at joints

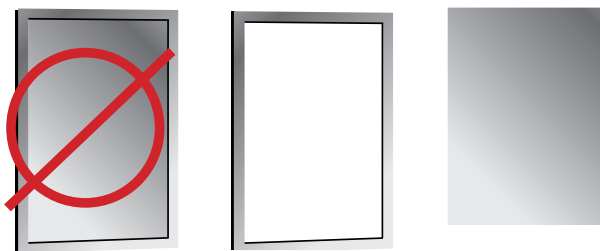

Figure 7: Galvanized thick frames separate from thin sheet/plate

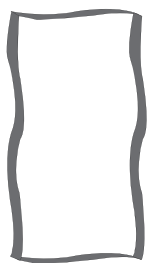

Figure 8: Add stiffeners to unsupported flat sheets

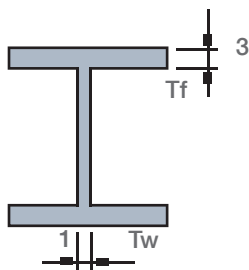
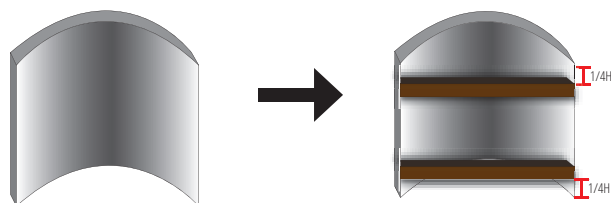

Figure 9: Keep flange-to-web thickness less than 3-to-1



Channel frame  
(typically fabricated toe-out)

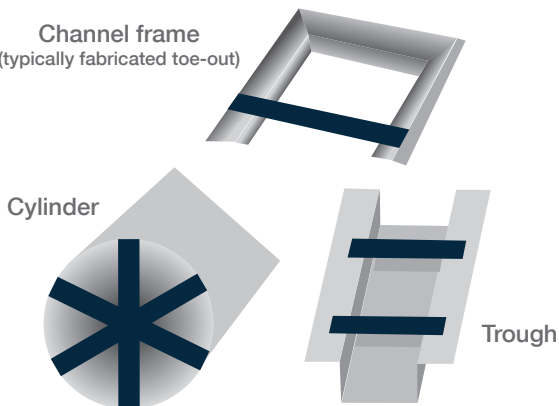

Figure 10: Temporary bracing

## TIPS FOR MINIMIZING DISTORTION

- Use lighter gauge sheets/plates (1/4 inch thick or less) with caution, as they are susceptible to warpage. If necessary, sheet/plate can often be returned to a flattened state using a jig or by weighing down the product on a flat surface during cool down.
- Avoid or minimize fabrication practices that induce local stress concentration such as:
  - Punched holes, rolling, riveting, bending and straightening
  - Keep bending to the largest acceptable radii, and where a tight bend radii is required, stress relieve the area per the guidelines in ASTM A143, Section 6.
  - Accurately pre-form members of an assembly so it is not necessary to force, spring, or bend them into position during joining.
- Use parts in an assembly of equal or near equal thickness, especially try to avoid:
  - Unequal thickness at joints (*Figure 6*)
  - Surrounding thinner material with thick framing (*Figure 7*)
  - Unsupported flat sheet assemblies (*Figure 8*)
  - Flange-to-web thickness ratios greater than 3 to 1 for fabricated beams (*Figure 9*)
- Use temporary bracing or reinforcing on thin-walled and asymmetrical designs (*Figure 10*).
  - Where possible, use symmetrically rolled sections in preference to angle or channel frames. I-beams are preferred to angles or channels.
  - Dip tees flange-side first, and channels web-side first with quickest possible immersion at largest possible dip angle, and air cool (*Figure 11*).
  - Assemble two asymmetrical sections (*Figure 12*) back to back to create a symmetrical section or galvanize as separate items and join after.
- Continuously weld joints using balanced welding techniques to reduce uneven thermal stresses. Pinholes from welding are very dangerous in items to be galvanized and must be avoided. Staggered welding techniques to produce a structural weld are acceptable. For staggered welding of 1/8-inch (4 mm) or lighter material, weld centers should be closer than 4 inches (10 cm).
- Avoid designs that require progressive-dip galvanizing. It is preferable to build assemblies and subassemblies in suitable modules that can be immersed quickly and galvanized in a single dip, so the entire fabrication can expand and contract uniformly. Where progressive dipping is required, consult your galvanizer to discuss thermal expansion conditions.
- Optimize venting, drainage, and lifting for long/slender products (*Figure 13*).
- Ensure proper laydown after galvanizing, particularly for supporting mid portions of long/slender products and supporting the strong axis of a camber beam (*Figure 14*).

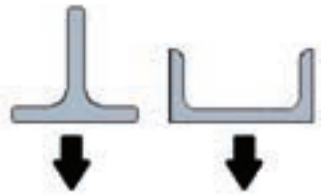
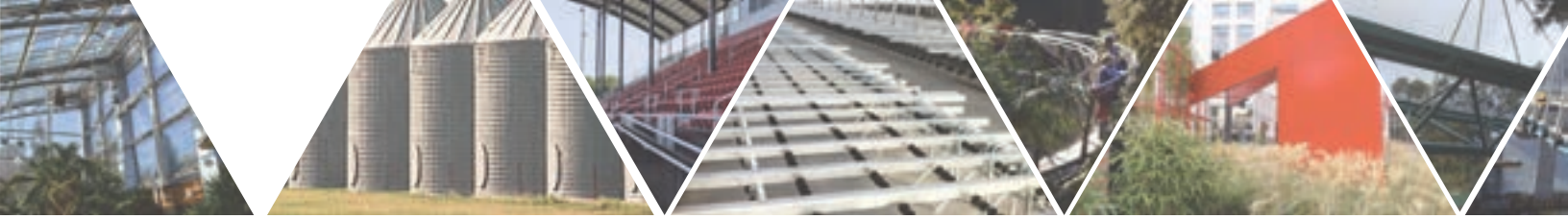

Figure 11: Dip tees flange-side first and channels web-side first

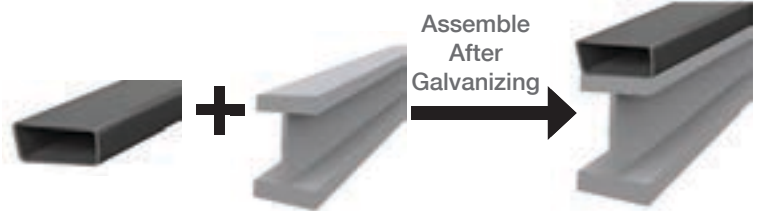
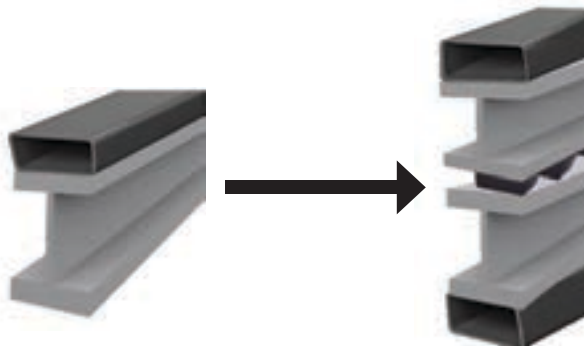

Figure 12: Assemble asymmetrical sections back to back or galvanize individual parts as separate items and assemble after galvanizing

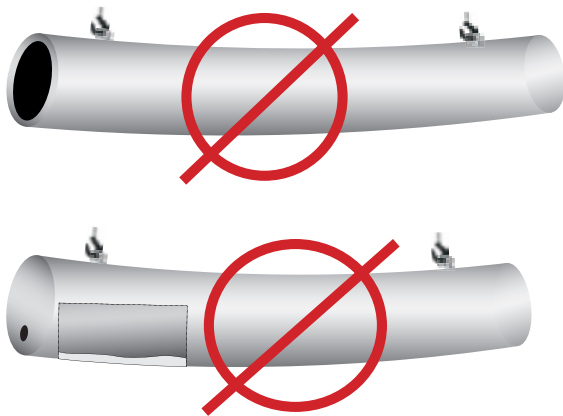

Figure 13: Optimize venting and drainage to prevent trapped zinc and lift points for galvanizing should be located at quarter points along the product length.



Figure 14: Avoid leaving mid-portion of products unsupported, products should be laid with supports to prevent sagging or to support a camber.



## ALLOWING FOR PROPER DRAINAGE

For effective galvanizing, cleaning solutions and molten zinc must flow without undue resistance into, over, through, and out of the fabricated article. Failure to provide free, unimpeded flow can result in complications for the galvanizer and the customer.

Improper drainage design results in poor appearance, bare spots, and excessive build-up of zinc. All of these are unnecessary and costly, and a great example of why communication throughout the project is key.

A few common fabrications where drainage is important are gusset plates, stiffeners, end-plates, and bracing. Following these best design practices will help ensure the highest quality coatings:

- Where gusset plates are used, generously cropped corners provide for free drainage. When cropping gusset plates is not possible, holes at least 1/2-inch (13 mm) in diameter must be placed in the plates as close to the corners as possible (*Figure 15*, below).
- To ensure unimpeded flow of solutions, all stiffeners, gussets, and bracing should be cropped a minimum of 3/4-inch (19 mm) (*Figure 16*). Provide holes at least 1/2-inch (13 mm) in diameter in end-plates on rolled steel shapes to allow molten zinc access during immersion in the galvanizing bath and drainage during withdrawal.
- Alternatively, holes at least 1/2-inch (13 mm) in diameter can be placed in the web within 1/4-inch (6 mm) of the end-plate. To facilitate drainage, end-plates should have holes placed as close to interior corners as possible (*Figure 17*).

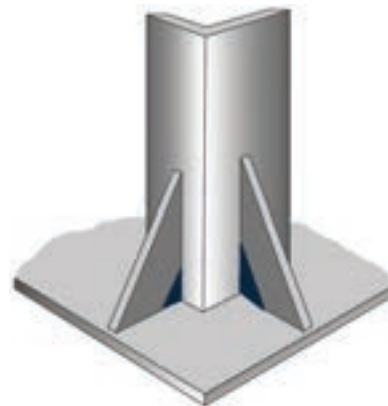

Figure 16: Cropped bracing

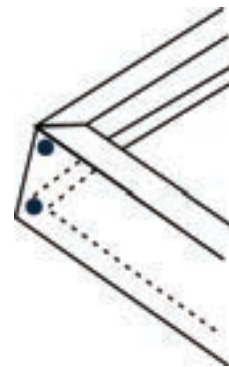

Figure 17: Holes in end-plate

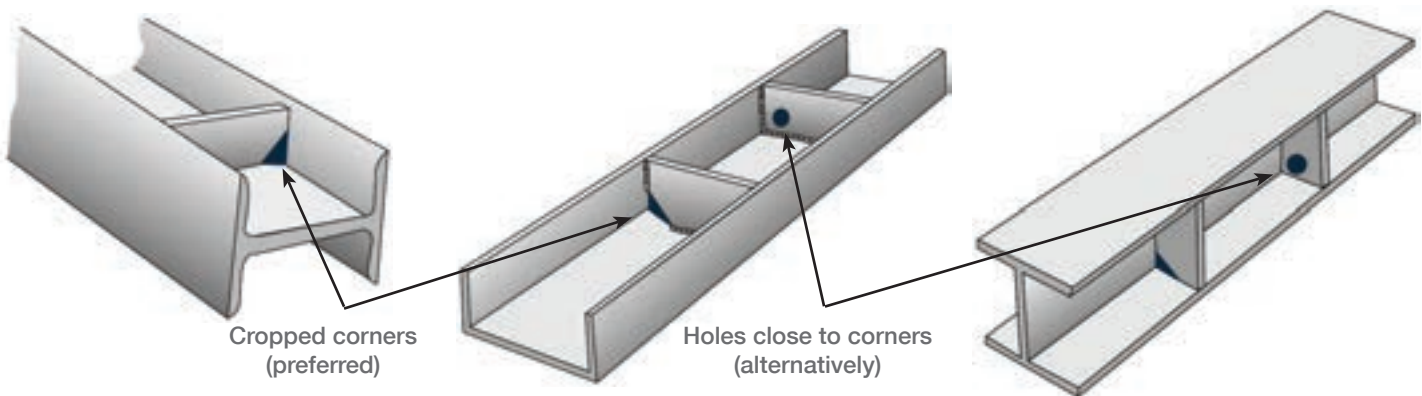

Figure 15: Cropped gusset plate corners

## VENTING TUBULAR FABRICATIONS & HOLLOW STRUCTURALS

Tubular assemblies (handrails, pipe columns, pipe girders, street light poles, transmission poles, pipe trusses, sign bridges) are commonly galvanized because corrosion protection is afforded to the interior and exterior of the product. To provide an optimal galvanized coating, hollow products require proper cleaning, venting, and draining.

As with all steel, pipe and other hollow materials must be thoroughly cleaned for the molten zinc to metallurgically bond with the steel. Cleaning solutions should be free to move into and completely wet all surfaces of the fabrication, and when removed, no solutions should be trapped inside.

Pipe can present two special cleaning challenges. First, the mill coating (varnish, lacquer, and similar materials) applied by pipe manufacturers requires extra time and effort to remove at the galvanizing plant. Some galvanizers do not have the



capability to remove this coating. Some organic mill coating formulations, both foreign and domestic, are extremely difficult to remove with common cleaning solutions, so blasting may be required. Ordering uncoated pipe avoids costly attempts to remove these mill coatings. In some cases, it may be more cost effective to substitute tube for pipe.

The second challenge to cleaning pipe is also related to the mill coatings. Welding around mill coatings burns and carbonizes the varnish in the surrounding areas and cannot be removed by the normal cleaning process at a galvanizer. This soot must be removed by blasting or other mechanical cleaning methods prior to delivering steel to the galvanizing facility.

The primary reason for vent and drain holes is to allow air to be evacuated, permitting the object to be completely immersed into cleaning solutions and molten zinc. Proper hole sizing and location make it safer to galvanize and provide an optimal finish. The secondary reason for venting/drainage is to prevent damage to the parts. Any pickling solutions or rinse waters that might be trapped in a blind or closed joining connection will be converted to superheated steam or gas and can develop a pressure of up to 3,600 psi (1,100 MPa) when immersed in molten zinc.

Not only does that pressure have the ability to damage the fabrication being galvanized, but can also put galvanizing personnel and equipment at risk. Therefore, in order to safely and effectively provide corrosion protection on the inside of hollow pieces, ample passageways allowing unimpeded flow into and out of the part must be designed into assemblies. Proper galvanizing results when the inside and outside of a product are completely cleaned and zinc-coated.

Items are immersed and withdrawn from the galvanizing kettle at an angle; thus, the vent holes should be located at the highest point and drain holes at the lowest. All sections of fabricated pipe-work should be interconnected with full open-tee or miter joints. Each enclosed section must be provided with a vent hole at each end. It is recommended tubular structures be completely submerged; in one dip. This minimizes potential internal coating problems that because of the size and shape of the item may be difficult to discover during inspection.

Most galvanizers prefer to visually identify venting from the outside, in order to verify the adequacy of the venting as well as to determine that venting has not been mistakenly omitted. Some galvanizers may hesitate to process complicated pipe assemblies unless all venting is visible on the outside and readily accessible for inspection (*Figure 18*).

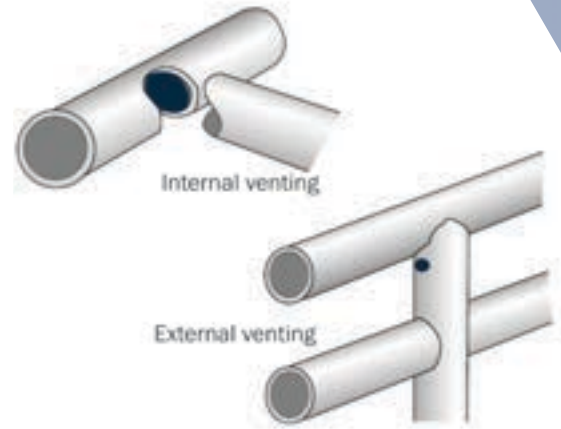

Figure 18: Venting

Base-plates and end-plates must be designed to facilitate venting and draining. Fully cutting the plate provides minimum obstruction to a full, free flow into and out of the pipe. Since this is not always possible, using vent holes in the plate often provides the solution.

Vent holes are frequently left open but can be closed with drive caps or plugs after galvanizing. Various methods of venting are acceptable (*Figure 19*), but the subsequent plugging of these holes should be kept in mind, where necessary or desired. The most common method to plug vent and drain holes is to seal with zinc or aluminum plugs which are pushed into the holes and filed flush with the surrounding coating. Aluminum plugs can be specified for mild and moderately corrosive environments with minimal impact on corrosion performance. For more corrosive environments, utilize zinc plugs to avoid galvanic corrosion.

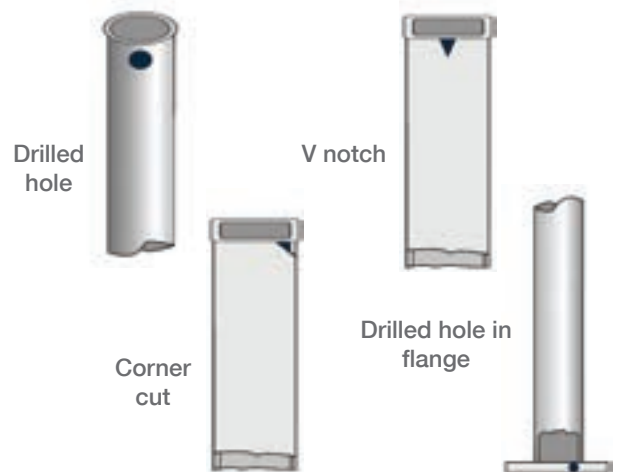

Figure 19: Vent hole options

The following drawings illustrate recommended designs for tubular fabrications and hollow structures. The vent dimensions given are the minimum required.

## HANDRAIL (FIGURES 20 & 21)

Figure 20 illustrates the most desirable design for fabrications of handrail for galvanizing. It shows internal venting as well as the minimum amount of external vent holes.

1. External vent holes must be as close to the weld as possible and not less than 3/8-inch (9.5 mm) in diameter.
2. Internal holes should be the full internal diameter (ID) of the pipe for the best galvanizing quality and lowest galvanizing cost.
3. Vent holes in end sections or in similar sections must be 1/2-inch (12.7 mm) in diameter.
4. Ends should be left completely open. Any device used for erection in the field that prevents full openings on ends of horizontal rails and vertical legs should be galvanized separately and attached after galvanizing.

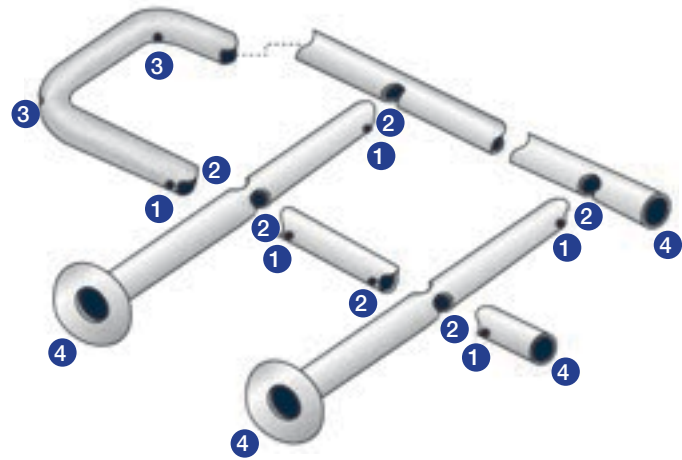

Figure 20: Vent holes should be visible on the outside of any pipe assembly to provide internal vent verification

Figure 21 illustrates an acceptable alternative if full internal holes (the full ID of the pipe) are not incorporated into the design of the handrail.

1. Each external vent hole must be as close to the welds as possible and must be 25% of the ID of the pipe, but not less than 3/8-inch (10 mm) in diameter. The two holes at each end and at each intersection must be 180° apart and in the proper location as shown.
2. Vent holes in end sections or in similar sections must be 1/2-inch (13 mm) in diameter.
3. Ends should be left completely open. Any device used for erection in the field that prevents full openings on ends of horizontal rails and vertical legs should be galvanized separately and attached after galvanizing.

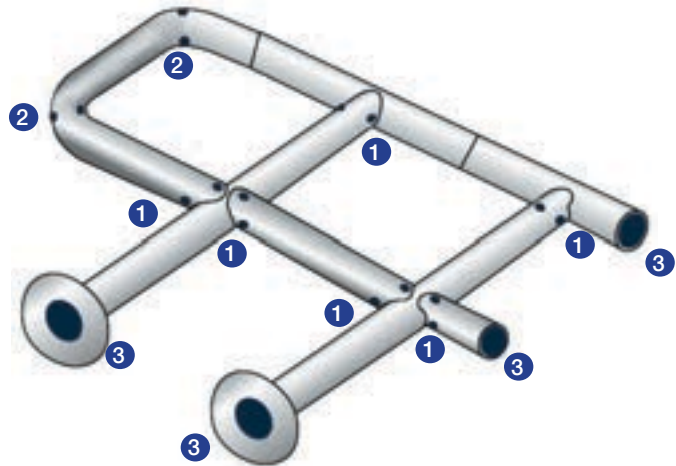

Figure 21: External vent holes should be visible on the outside of pipe assemblies

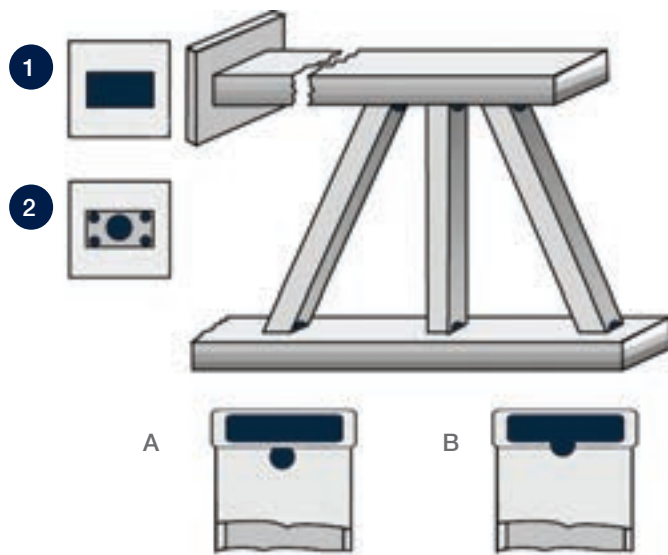

Figure 22: Holes at either end of the rectangular tube trusses should be completely open

## RECTANGULAR TUBE TRUSS (FIGURE 22)

### Vertical Sections

Examples A and B in Figure 22 show proper hole locations for the vertical members. Each vertical member should have two holes at each end, 180° apart in line with the horizontal members. Preferably, the size of the holes should be equal, and the combined area of the two holes at either end should be at least 30% of the cross-sectional area.

### End Plates - Horizontal

1. The most desirable fabrication is completely open.
2. From Figure 22, if  $H + W = 24"$  (61 cm) or larger, the area of the hole, plus clips, should equal 25% of the area of the tube ( $H \times W$ ).
  - If  $H + W =$  less than 24" (61 cm) but more than 16" (41 cm), the area of the hole, plus clips, should equal 30% of the area of the tube.
  - If  $H + W =$  less than 16" (41 cm) but more than 8" (20 cm), the area of the hole, plus clips, should equal 40% of the area of the tube.
  - If  $H + W =$  less than 8" (20 cm), leave it open.

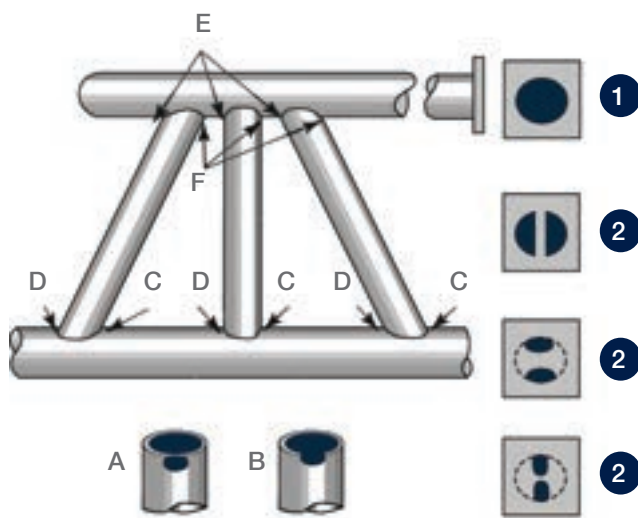

Figure 23: Vent and drain holes should be the same size as the tubing, or one of the shown alternatives

## PIPE TRUSS 3" (7.6 CM) & LARGER (FIGURE 23)

### Vertical Sections

Hole locations for the vertical members should be as shown in examples A and B in Figure 23. Each vertical member should have two holes at each end and 180° apart in line with the horizontal members as indicated by the arrows. Preferably, the size of the holes should be equal and the combined area of the two holes at either end of the verticals (Areas C and D or Areas E and F) should be at least 30% of the cross-sectional area.

### End Plates - Horizontal

1. The most desirable fabrication is completely open with the same hole diameter as the tube's ID.
2. Equal substitutes would have openings as shown and would be at least 30% of the ID.



## PIPE COLUMNS, PIPE GIRDERS, STREET LIGHT & TRANSMISSION POLES (FIGURE 24)

With base plates and with or without cap plates

### Location of Openings

1. Most desirable fabrication is end completely open, with same diameter as the section top and bottom.
2. Equal substitute if the full opening is not allowed.
3. Equal substitute if the full opening is not allowed.
4. Equal substitute if the full opening is not allowed.
5. This must be used when no holes are allowed in the cap- or base-plate: two half-circles 180° apart and at opposite ends of the pole.

### Dimensions (Figure 24)

For pipe 3" (7.6 cm) and greater, openings at each end must be at least 30% of the ID of the pipe. For pipe smaller than 3" (7.6 cm), opening must be at least 45% of the ID. The following is an example of sizes for a 6-inch (15.2 cm) diameter section:

1. End completely open
2. Slot A = 3/4-inch (19 mm), Center hole B = 3 inches (7.6 cm) diameter
3. Half circle C = 1 3/4-inch (4.4 cm) radius
4. Oval opening = 1 3/4-inch (4.4 cm) radius
5. Half circle D = 1 5/8-inch (4.1 cm) radius

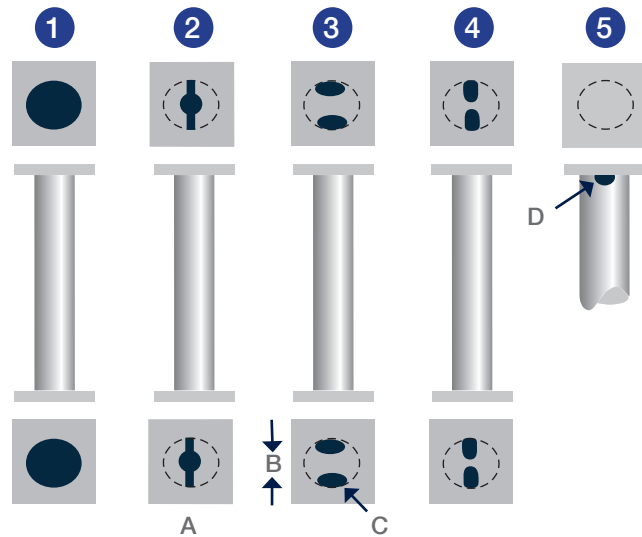

Figure 24: Pipe columns, pipe girders, street light poles, and transmission poles

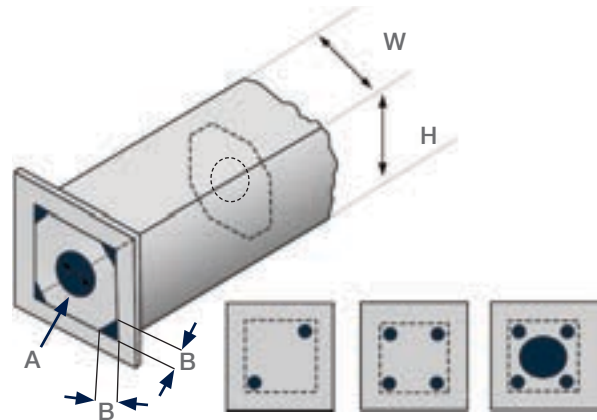

Figure 25: Box Sections

## BOX SECTIONS (FIGURE 25)

Figure 25 shows the location of holes and clipped corners, which must be flush. Using the following formulas, Table 1 shows typical sizes of holes for square box sections only. For rectangular section, calculate the required area and check with your galvanizer for positioning of openings.

### Internal Gussets – space at a minimum of 36" (91.4 cm)

#### Box Sections

- $H + W = 24"$  (61 cm) or larger, the area of the hole, plus clips, should equal 25% of the cross-sectional area of the box ( $H \times W$ ).
- $H + W =$  less than 24" (61 cm) but greater than 16" (38.4 cm), the area of the hole, plus clips, should equal 30% of the cross-sectional area of the box.
- $H + W =$  less than 16" (38.4 cm) but greater than or equal to 8" (19.2 cm), the area of the hole, plus clips, should equal 40% of the cross-sectional area of the box.
- $H + W =$  under 8" (19.2 cm), leave completely open, no end-plate or internal gusset.

Box Size (H+W)	Hole Diameter (A)	Clipped Corner Length (B)
48" (122 cm)	8" (203 mm)	6" (152 mm)
36" (91.4 cm)	6" (152 mm)	5" (127 mm)
32" (81.3 cm)	6" (152 mm)	4" (102 mm)
28" (71 cm)	6" (152 mm)	3" (76 mm)
24" (61 cm)	5" (127 mm)	3" (76 mm)
20" (50.8 cm)	4" (102 mm)	3" (76 mm)
16" (40.6 cm)	4" (102 mm)	2" (51 mm)
12" (30.5 cm)	3" (76 mm)	2" (51 mm)

TABLE 1: TYPICAL HOLE SIZES FOR BOX SECTIONS



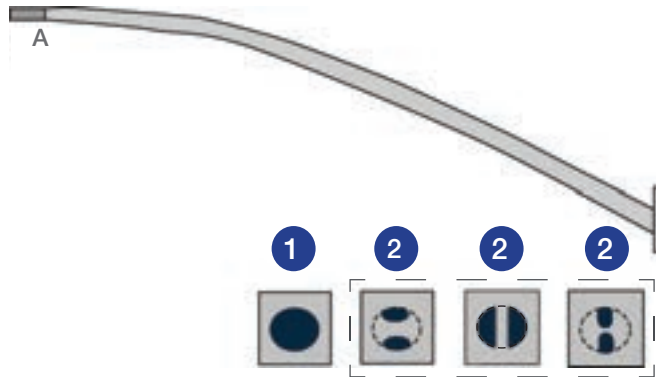

Figure 26: Tapered - signal arm

### TAPERED – SIGNAL ARM (FIGURE 26)

The small end “A” should be completely open.

#### Pole Plate End

1. The most desirable fabrication is to have the end completely open.
2. Acceptable alternatives, the half-circles, slots, and round holes must equal 30% of the ID of the pole end of the tapered arm for 3” (7.6 cm) and larger. The opening must equal 45% of the pole end of the tapered arm if the ID is less than 3” (7.6 cm).

Internal gusset-plates and end-flanges should also be provided with vent and drainage holes. In circular hollow shapes, the holes should be located diametrically opposite each other at opposite ends of the member.

In rectangular hollow shapes, the four corners of the internal gusset-plates should be cropped. Internal gusset-plates in all large hollow sections should be provided with an additional opening at the center. Where there are flanges or end-plates, it is more economical to locate holes in the flanges or plates rather than in the section.

## PROPER VENTING & DRAINAGE OF ENCLOSED & SEMI-ENCLOSED FABRICATIONS

Tanks and enclosed vessels should be designed to allow cleaning solutions, fluxes, and molten zinc to enter at the bottom and air to flow upward through the enclosed space and out through an opening at the highest point. This prevents air from being trapped as the article is immersed (Figure 27). The design must also provide for complete drainage of both interior and exterior details during withdrawal. The location and size of fill and drain holes are important. As a general rule, the bigger the hole the better the air and zinc flow.

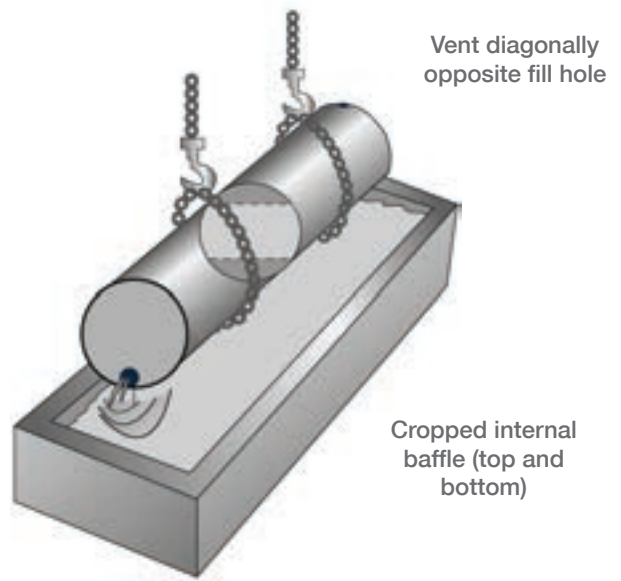

Figure 27: Venting of enclosed fabrications

When both internal and external surfaces are to be galvanized, at least one fill/drain hole and one vent hole must be provided. The fill/drain hole should be as large as the design will allow, but at least 3 inches in diameter for each cubic yard (10 cm in diameter for each cubic meter) of volume. The minimum diameter is 2 inches (5 cm). Provide vent holes of the same size diagonally opposite the fill/drain hole which allows the air to escape.



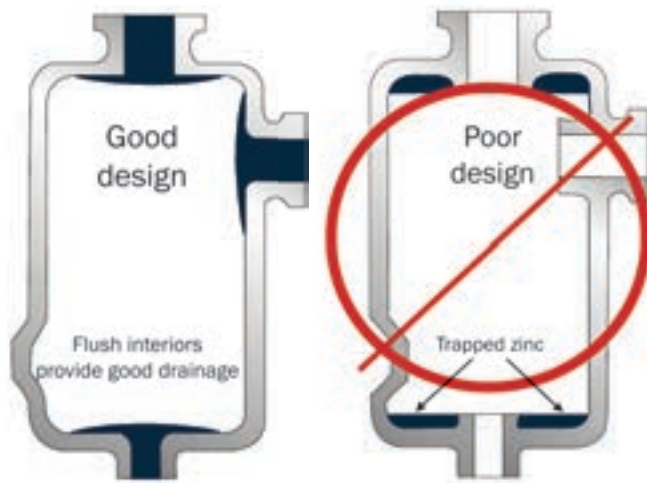

Figure 28: Proper and improper venting

In tanks, internal baffles should be cropped on the top and bottom or provided with suitable drainage holes to permit the free flow of molten zinc. Manholes, handholes, and openings should be finished flush inside to prevent trapping excess zinc (Figures 28-29). Openings must be placed so the flux on the vessel can float to the surface of the bath. These openings also prevent air-pocket formations that may keep solutions from completely cleaning the inside of the vessel.

Items such as vessels or heat exchangers galvanized on the outside only must have snorkel tubes, or extended vent pipes. These openings provide an air exit from the vessel above the level of molten zinc in the galvanizing kettle (Figure 30). Consult your galvanizer before using these temporary fittings, because special equipment is needed.

Communication with your galvanizer, including review of the drawings of enclosed or partially enclosed vessels before fabrication, is critical. Galvanizers may recommend changes that would provide a better galvanized product, and the least expensive time to make any changes that may be warranted is before fabrication.

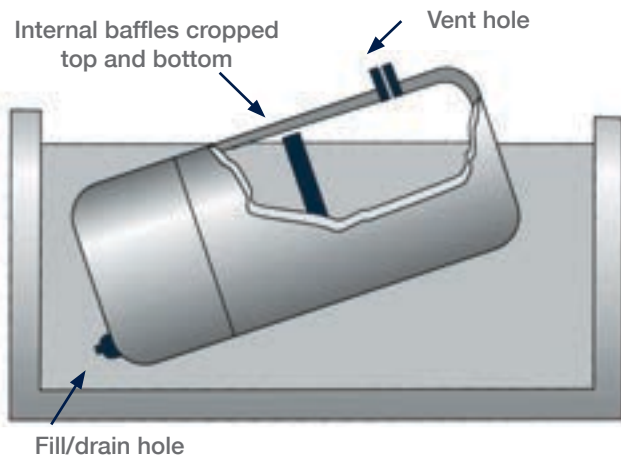

Figure 29: Tank

### TIGHTLY OVERLAPPING SURFACE CHALLENGES

- Cleaning solutions that may be trapped will flash to steam when the part is immersed in the galvanizing bath. This steam can wash the flux off of the part near the gap, causing bare areas adjacent to the lap joint.
- Cleaning solution salts can be retained in these tight areas due to the impossibility of adequate rinsing. The galvanized coating may be of good quality in the adjacent area, but humidity encountered weeks or even months later may wet these salts. This will cause unsightly rust staining to seep out onto the galvanized coating.
- Cleaning solutions will not effectively remove oils and greases trapped between surfaces in close contact. Any residual oil and grease will partially volatilize at the galvanizing temperature. This will result in an unsatisfactory zinc coating in the immediate area of the lap joint.
- Venting sizes for tightly overlapping surfaces are listed in Table 2 (next page).

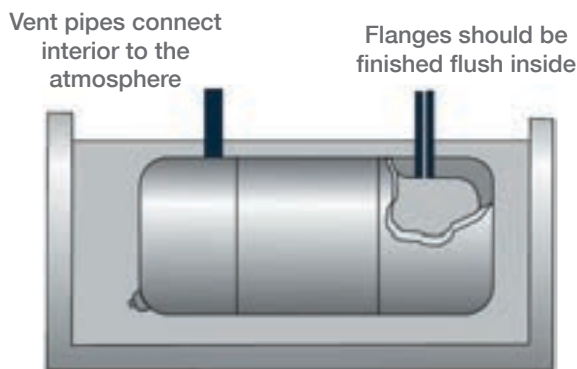

Figure 30: Tank



## PRECAUTIONS FOR OVERLAPPING & CONTACTING SURFACES

When designing articles to be galvanized after fabrication, it is best to avoid narrow gaps between plates, overlapping surfaces, back-to-back angles, and channels, whenever possible (Figure 31).



Figure 31: Overlapping Surfaces

When overlapping of contacting surfaces cannot be avoided and the gap is 3/32-inch (2.5 mm) or less, all edges should be completely sealed by welding. The viscosity of the zinc keeps it from entering any space tighter than 3/32-inch (2.5 mm). If there is an opening, less viscous cleaning solutions will enter but zinc will not. Trapped solutions may cause iron oxide to weep out of the joint later on.

It is important to contact your galvanizer before constructing any piece that includes overlapping surfaces. The trade-off between a completely sealed weld joint that may undergo expansion and cracking when subjected to galvanizing temperatures and a skip-welded joint that may experience weepage and staining later becomes a very difficult choice. Your galvanizer's experience can be very beneficial to assist you in making this decision.

When a weld joint is completely sealed, there must be no weld imperfection or pinholes. The penetration of moisture into the sealed cavity could cause significant safety hazards during the hot-dip galvanizing process as the sealed air will greatly expand when the part reaches the galvanizing temperature. This gas expansion can cause the molten zinc to splash out of the bath and endanger galvanizing workers.

If the area of a seal-weld overlap is large, there should be vent holes through one or both sides into the lapped area. This is to prevent any moisture that gets in through a pinhole in the weld from building up excessive pressure while in the galvanizing bath. This venting becomes more important the greater the area. Consult your galvanizer or Table 2 (below) for vent size and quantity.

Where two bars come together at an angle, a gap of at least 3/32-inch (2.5 mm) after welding must be provided to ensure the area is wetted by the molten zinc (Figure 32). An intermittent fillet weld may be used. This can be on one side of the bar only, or where necessary, an intermittent staggered fillet weld may be employed on both sides so that a pocket is not formed. However, this type of welding may not be suitable for load-bearing members.



Figure 32: 3/32 inch (2.5mm) gap after welding

Overlapped Area in <sup>2</sup> (cm <sup>2</sup> )	Vent Holes for Overlapped Areas for Steels ½ in. (12.75 mm) or Less in Thickness		Vent Holes for Overlapped Areas for Steels Greater than ½ in. (12.75 mm) in Thickness	
	Vent Holes	Unwelded Area	Vent Holes	Unwelded Area
under 16 (103)	None	None	None	None
16 (103) to under 64 (413)	One 3/8 in (1 cm)	1 in (2.5 cm)	None	None
64 (413) to under 400 (2580)	One ½ in (1.25 cm)	2 in (5.1 cm)	One ½ in (1.25 cm)	2 in (5.1 cm)
400 (2580) and greater, each 400 (2580)	One ¾ in (1.91 cm)	4 in (10.2 cm)	One ¾ in (1.91 cm)	4 in (10.2 cm)

TABLE 2: VENTING SIZES FOR OVERLAPPED SURFACES



## WELDING PROCEDURES & WELDING FLUX REMOVAL

When welded items are galvanized, the cleanliness of the weld area and the metallic composition of the weld itself influence the galvanized coating's characteristics. Galvanized materials may be easily and satisfactorily welded by all common welding techniques. The specific techniques can best be obtained from the American Welding Society ([aws.org](http://aws.org) or 800-443-9353) or your welding equipment supplier. Additional information about welding galvanized steel may be obtained from the AGA.

Welding rods high in silicon may cause excessively thick and/or darkened galvanized coatings to form over the weld. In smooth products welded together with high-silicon weld rods, the coating over the weld material will be thicker than the surrounding coating, causing a bump in an otherwise smooth product. A very low-silicon rod may need to be used.

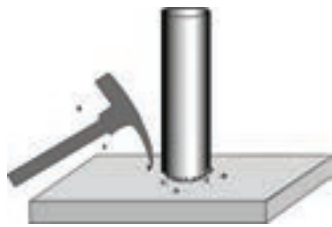

Figure 33: Chipping away weld flux residues

### TIPS FOR WELDING BEFORE GALVANIZING

- In welding, an uncoated electrode should be used when possible to prevent flux deposits on the steel or product.
- Welding flux residues are chemically inert in the pickling solutions commonly used by galvanizers; therefore, their existence will produce rough surfaces and coating voids. If a coated electrode is used, all welding flux residues must be removed by wire brushing, chipping, grinding, pneumatic needle gun, or abrasive blast cleaning (Figure 33).
- Welding processes such as metal inert gas (MIG), tungsten inert gas (TIG), or carbon dioxide (CO<sub>2</sub>) shielded are recommended since they essentially produce no slag. However, there can still be small flux-like residues that need to be chipped off.
- In the case of heavy weldments, a submerged arc method is recommended.
- If none of these welding methods is available, select a coated rod specifically designed for "self-slugging," as recommended by welding equipment suppliers.
- Choose a welding rod providing a deposited weld composition as close as possible to the parent metal. The composition and compatibility will yield a more uniform galvanized coating appearance.

## THREADED PARTS

Hot-dip galvanized fasteners are recommended for use with hot-dip galvanized assemblies and subassemblies. Galvanized nuts, bolts, and screws in common sizes are readily available from commercial suppliers. Bolted assemblies should be sent to the galvanizer in a disassembled condition. Nuts, bolts, or studs to be galvanized also should be supplied disassembled.

Because hot-dip galvanizing is a coating of corrosion-inhibiting, highly abrasion-resistant zinc on bare steel, the original steel becomes slightly thicker. When talking about tapped holes and fasteners, the increased thickness is important.

Bolts are completely galvanized, but internal threads on nuts must be tapped after galvanizing to accommodate the increased diameter of the coated bolts. While tapping the nuts after galvanizing results in an uncoated female thread, the zinc coating on the engaged male thread will protect both components from corrosion. For economy, nuts are usually galvanized as blanks and the threads tapped after galvanizing (Figure 34).



Figure 34: Overtapped Nut

Table 3 (next page) shows the recommended overtapping for nuts and interior threads as detailed in ASTM A563, *Specification for Carbon and Alloy Steel Nuts*. On threads over 1-1/2-inches (38 mm) it is often more practical, if design strength allows, to have the male thread cut 0.031-inches (0.8 mm) undersize before galvanizing so a standard tap can be used on the nut. Where possible, tapping of threaded holes after galvanizing is recommended to eliminate double-tapping costs and the possibility of cross-threading.

To remove excess zinc and produce smoother coatings, small parts, including fasteners, are centrifuged in special equipment when they are removed from the galvanizing bath. Items too long or too large to centrifuge, such as long threaded rods, may be brushed while hot to remove any excess zinc from the threads. Studs welded to assemblies may have to be cleaned after the assembly has cooled. This requires reheating with an acetylene torch and brushing to remove excess zinc. Alternatives to welded studs should be considered when possible.

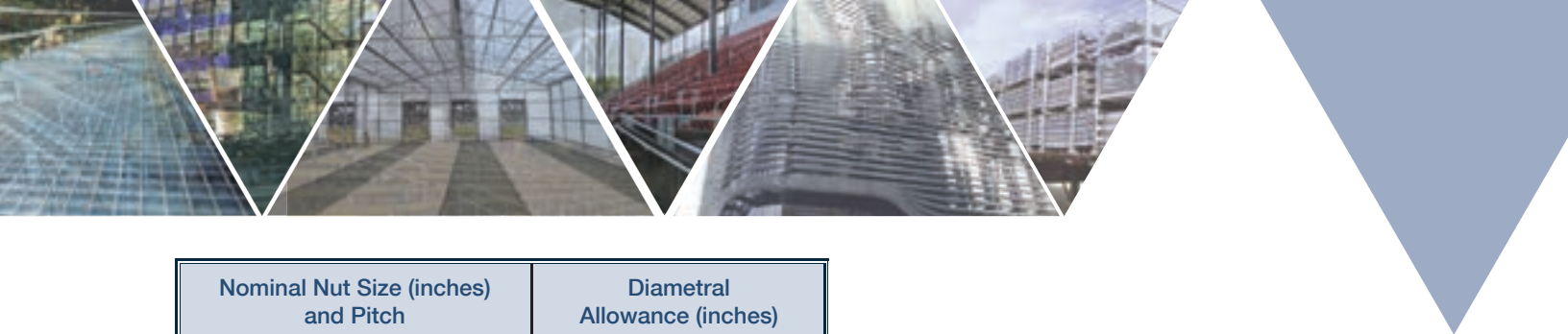

Nominal Nut Size (inches) and Pitch	Diametral Allowance (inches)
0.250-20	0.016
0.312-18	0.017
0.375-16	0.017
0.437-14	0.018
0.500-12	0.018
0.562-12	0.020
0.625-11	0.020
0.750-10	0.020
0.875-9	0.022
1.000-8	0.024
1.125-8	0.024
1.125-7	0.024
1.250-8	0.024
1.250-7	0.024
1.375-8	0.027
1.375-6	0.027
1.500-8	0.027
1.500-6	0.027
1.750-5	0.050
2.000-4.5	0.050
2.500-4.5	0.050
2.500-4	0.050
2.750-4	0.050
3.000-4	0.050
3.250-4	0.050
3.500-4	0.050
3.750-4	0.050
4.000-4	0.050
*For metric overtapping allowance see ASTM A563M, Section 7	

**TABLE 3: OVERTAPPING GUIDELINES FOR NUTS & INTERIOR THREADS**

Masking to prevent galvanizing threads on pipe or fittings is very difficult. The recommended practice is to clean and tap after galvanizing. Anchoring devices (such as threaded rods and anchor bolts) sometimes are specified to be galvanized in the threaded areas only or in the areas to be exposed above ground. This can be more expensive than galvanizing the complete unit because of the additional handling required. Complete galvanizing can be specified for items to be anchored in concrete. Research has proven the high bond strength and performance of galvanized steel in concrete.

Depending on the type of structural connection, through-holes may be oversized if they are to contain a galvanized bolt after assembly. Section J3.2 of the *AISC Manual of Steel Construction: Load and Resistance Factor Design (LRFD manual)* states oversized holes are not to be used in bearing type connections. Consequently, this may necessitate unblocking or reaming of the hole after galvanizing.

For slip critical connections, a clearance hole 1/8 inch larger than the nominal bolt diameter is sufficient to provide a clearance hole that will accommodate a galvanized bolt without the need of extra hole cleaning. For slip critical connections involving bolts sized one inch or greater, specify standard clearance hole sizes in accordance with ANSI/AISC 360 Specification for *Structural Steel Buildings* or *AASHTO LRFD Bridge Design Specifications*, as the standard hole is already sized 1/8 inch greater than the bolt diameter. For connections where the specified bolt size is less than 1 inch, specify oversized holes which are 1/8 inch greater than the nominal bolt diameter.

For other types of connections that require more hole clearance for alignment reasons, the maximum dimensions for oversizing can be found within Section J3.1, Table J3.3 of the AISC LRFD manual, or in Table 4.

When oversized holes are used, the designer must evaluate the reduction in slip capacity due to the reduction in the connection area in order to ensure slip does not occur. Relevant specifications require the design slip resistance be reduced 15% for connections using oversized through-holes which leads to additional bolts in the connection design. Furthermore, the use of oversized holes may not be allowed for certain designs such as bolted splices of bridge girders.

Nominal Bolt Diameter (db) [in]	Standard Clearance Hole Diameter [in]	Hole Diameter for minimizing reaming after HDG [in]	Maximum Clearance Hole Diameter [in]
1/4	5/16	3/8	3/8
1/2	9/16	5/8	5/8
5/8	11/16	6/8	13/16
3/4	13/16	7/8	15/16
7/8	15/16	1	1-1/16
1	1-1/8	1-1/8	1-1/4
$d_b \geq 1-1/8$	$d_b + 1/8$	$d_b + 1/8$	$d_b + 5/16$

**TABLE 4: CLEARANCE HOLE SIZES FOR USE IN SLIP CRITICAL CONDITIONS**



Manufacturers of threaded parts recognize special procedures must be followed in their plants when certain items are to be galvanized. Following are some examples:

- Low carbon bars are recommended since high carbon or high silicon cause a heavier, rougher galvanized coating on the threads.
- Hot-formed heading or bending requires cleaning at the manufacturing plant to remove scale before threading. Otherwise, over-pickling of threads will result during scale removal.
- Sharp manufacturing tools are mandatory. Ragged and torn threads open up in the pickling and galvanizing processes. Worn tools also increase bolt diameters. Frequent checking is necessary on long runs.
- Standard sized threads are cut on the bolt, while standard sized nuts are tapped after galvanizing.

## MOVING PARTS

When a galvanized assembly incorporates moving parts (such as drop-handles, shackles, and shafts), a radial clearance of not less than 1/16-inch (1.5 mm) must be allowed to ensure full freedom of movement after the addition of zinc during galvanizing (*Figure 35*). Whenever possible, work should be designed so hinges can be bolted to frames, covers, bodies, and other items after galvanizing.

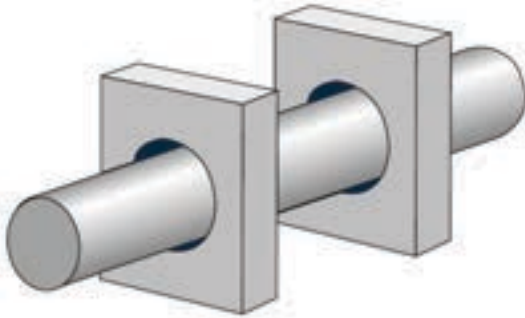

Figure 35: Shaft

Hinges should be galvanized separately and assembled after galvanizing. All hinges to be galvanized should be of the loose-pin type. Before galvanizing, any adjacent edges should be ground to give at least 1/32-inch (0.8 mm) clearance (*Figure 36*). The pin holes can be cleared of excess zinc during assembly. After hinges are galvanized, it is recommended an undersized pin be used to compensate for the zinc picked up during galvanizing. If desired, the pin holes in the hinges may be reamed 1/32-inch (0.8 mm) after galvanizing to permit the use of regular-size pins. On hinges, all adjacent surfaces must be ground 1/32-inch (0.8 mm) on both pieces to allow for thickness increases.

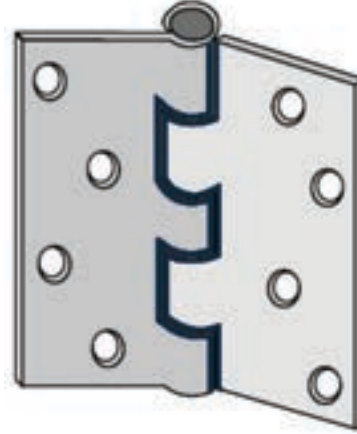

Figure 36: Hinge

At times, moving parts must be reheated in order for them to work freely. Although heating may cause discoloration of the galvanized coating near the reheated area, this discoloration does not affect the corrosion protection of the galvanized surface.

## ADDITIONAL DESIGN CONSIDERATIONS

### STRUCTURAL CONNECTIONS

The presence of a hot-dip galvanized coating on the contact surfaces of bearing type connections is not detrimental to performance, meaning hot-dip galvanizing can be used without affecting design strength considerations. For the design of hot-dip galvanized slip critical connections, the slip coefficient of galvanized faying surfaces must be considered.

For unprepared hot-dip galvanized faying surfaces, it is currently accepted that the surface will have the friction properties of a Class A surface (mean slip coefficient,  $\mu = 0.30$ ). Wire brushing should not be performed as a means of roughening the surface. A higher slip coefficient ( $\mu = 0.45$  or  $\mu = 0.50$ ) can be achieved by applying zinc-rich paints to hot-dip galvanized faying surfaces which have been prepared with a chemical pre-treatment/conversion coating. Additionally, for bridge and highway products, Class D surfaces (blast-cleaned surfaces including hot-dip galvanizing painted with Class D coatings,  $\mu = 0.45$ ) can be specified.

For detailed information on increasing the slip coefficient of hot-dip galvanized faying surfaces, contact the AGA Technical department or refer to the AGA Galvanizing Note *Slip Resistance of HDG Faying Surfaces with Zinc-Rich Paints*.



## MASKING

During the galvanizing process, all surfaces are cleaned and coated with zinc. For some purposes, intentionally ungalvanized areas are required. Masking, treating a portion of the steel surface so the area remains ungalvanized, may be performed to accomplish this. Masking is not an exact science; thus, additional work may still be required to remove unwanted zinc. In most cases, it may be easier to grind off the zinc coating after galvanizing than to the mask the material.

There are four major categories of masking materials:

1. Acid-resistant, high-temperature tapes
2. Water-based pastes and paint-on formulations
3. Resin-based, high-temperature paints
4. High-temperature greases and thread compounds

The AGA has completed a study evaluating the effectiveness of various common products as masking materials. This information is available for download or by contacting the AGA Technical Department.

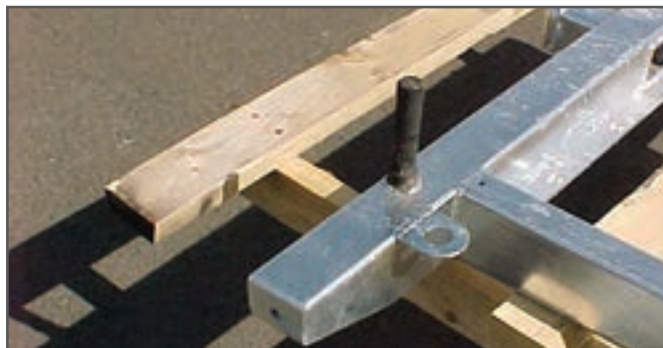

Masked lift points

## MARKING FOR IDENTIFICATION

Identification markings on fabricated items should be carefully prepared before galvanizing so they will be legible after galvanizing, but not disrupt the zinc coating's integrity. Cleaning solutions used in the galvanizing process will not remove oil-based paints, crayon markers or oil-based markers, so these products should not be used for applying addresses, shipping instructions, or job numbers. If these products are used, ungalvanized area may result.

Detachable metal tags or water-soluble markers should be specified for temporary identification. Alternatively, bar code tags are manufactured to survive the hot-dip galvanizing process and easily maintain identification.

Where permanent identification is needed, there are three suitable alternatives for marking steel fabrications to be hot-dip galvanized. Each enables items to be rapidly identified after galvanizing and at the job site (*Figure 37*).

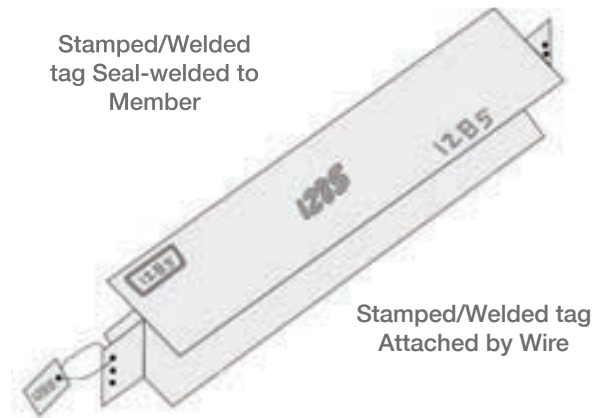

Figure 37: Permanent identification

Stamp the surface of the item using die-cut deep stencils or a series of center punch-marks. These marks should be placed in a standard position on each of the members, preferably toward the center. They should be a minimum of 1/2-inch (13 mm) high and 1/32-inch (0.8 mm) deep to ensure readability after galvanizing. This method should not be used to mark fracture-critical members.

A series of weld beads may also be used to mark letters or numbers directly onto the fabrication. It is essential that all welding flux be removed in order to achieve a quality galvanized coating (*Figure 38*).

Deep stenciling a steel tag (minimum #12 gauge) and firmly affixing it to the fabrication with a minimum #9 gauge steel wire is another option for identification (*Figure 39*). The tag should be wired loosely to the work so that the area beneath the wire can be galvanized and the wire will not freeze to the work when the molten zinc solidifies. If desired, tags may be seal-welded directly to the material.

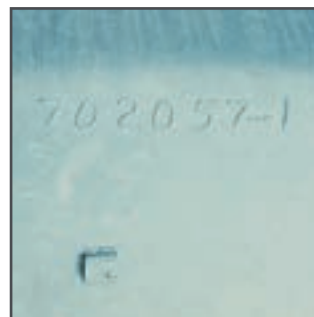

Figure 38: Weld beads may be used for identification



Figure 39: Tag affixed with a minimum #9 gauge steel wire

## POST-GALVANIZING CONSIDERATIONS

Once the fabrication has been successfully galvanized, there are a few additional considerations to take into account regarding storage and use. These best practices will ensure your galvanized project will provide maintenance-free corrosion protection as anticipated.

### DUPLEX SYSTEMS

A duplex system involves applying paint or powder coating over the hot-dip galvanized coating to achieve desired aesthetics or increased longevity. To achieve a successful duplex system, communication between the fabricator, specifier, painter, and galvanizer is vital before hot-dip galvanizing. The various parties may desire special handling or require alterations to the design to facilitate the galvanizing process and application of the paint/powder coating system. Furthermore, if the galvanizer is aware the part will be painted after galvanizing, precautions can be taken to avoid any processes that may interfere with the adhesion of the paint system.

Although some surface conditions present on hot-dip galvanized coatings do not affect the corrosion protection and are typically acceptable under ASTM A123/A123M (roughness, small dross inclusions, zinc runs, etc.), these surface conditions can affect adhesion of the top coating and present challenges when the part is duplexed. When the galvanizer is aware of the duplex specification, dross inclusions and skimmings can be removed or ground flat before powder coating. Especially when the galvanizer and the paint or powder coating applicator are comprised of two different parties, it is important to clarify responsibility and accountability for the following steps before the coatings are applied:

- Refraining from HDG post-treatments such as water/chromate quenching
- Surface smoothing
- Surface cleaning
- Profiling the surface
- Outgassing (powder coating only)

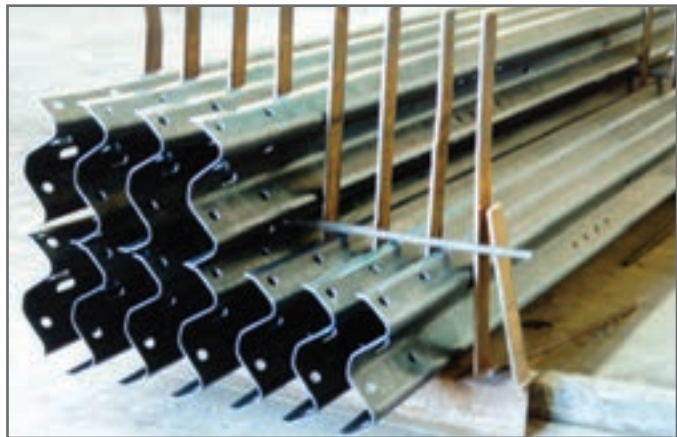

Proper storage of galvanized steel to avoid wet storage stain

### STORAGE

Zinc, like all metals, begins to corrode naturally when exposed to the atmosphere. However, zinc corrosion products actually form a tenacious, abrasion-resistant patina which helps to provide hot-dip galvanizing with its long service life. The formation of this patina depends on the galvanized coating being exposed to freely circulating air. Stacking galvanized articles closely together, or nesting, for extended periods of time, thereby limiting access to freely circulating air, can lead to the formation of a white powdery product known as wet storage stain (also labeled white rust). Visible formation of the white powdery product can also occur in heavy rain, dew, or high humidity conditions.

There are a number of simple guidelines (next page) to follow when storing or transporting newly galvanized steel which will help avoid wet storage stain and ensure your parts will age naturally, providing the best possible service life.

Wet storage stain is often superficial, despite the presence of a bulky white product. In the vast majority of cases, wet storage stain does not indicate serious degradation of the zinc coating, nor does it necessarily imply any likely reduction in







## TIPS TO AVOID WET-STORAGE STAIN

- Whenever possible, avoid nested stacking
- Provide adequate ventilation between stacked pieces
- Incline parts to allow for maximum drainage
- Stagger or cross stack galvanized pieces
- Elevate and separate articles stacked outdoors with strip spacers (poplar, ash, spruce); and during shipping if there is the likelihood of condensation
- Avoid stacking on wet soil or decaying vegetation
- Thoroughly dry small items that are quenched before packing in storage containers, and include a dehumidifying agent in sealed containers
- Whenever possible, store galvanized material under cover in dry, well-ventilated conditions, away from doorways open to the environment
- Treat with passivating agent
- Remove road salts from galvanized articles

the product's expected service life. If wet storage stain does form, the objects should be arranged so that their surfaces dry rapidly. Once dry, most stains can be easily removed by brushing with a stiff bristle (not wire) brush. This allows for the successful formation of galvanized coatings' protective zinc patina. For more information, see the AGA's publication, *Wet Storage Stain: A Guide to Preventing and Treating Wet Storage Stain on Hot-Dip Galvanized Steel*.



Poles with wet storage stain

## CLEANING GALVANIZED STEEL

- Use suitable personnel protective equipment
- Apply and remove cleaning product according to manufacturers instructions
- If needed, utilize stiff-bristle/nylon brush or similar to avoid damaging the coating
- Rinse with fresh water (twice recommended)
- Fully dry

## CLEANING GALVANIZED STEEL

Once in service, galvanized surfaces may need to be cleaned to remove graffiti or other contaminants. There are a number of products that can be used to successfully clean hot-dip galvanized steel without damaging the coating. **Contact the AGA for more details.**



Cleaning galvanized steel

## PERFORMANCE IN SERVICE ENVIRONMENT

Hot-dip galvanized steel's corrosion resistance is proven in various environmental conditions. The predictability of the coating lifetime is important for planning and budgeting for required maintenance. Because galvanizing has been used for corrosion protection for many years, a wealth of real-world, long-term exposure data on its performance is available. The corrosion resistance of hot-dip galvanizing varies depending on the environment, but generally corrodes at a rate of 1/30 of bare steel in a similar exposure.

Atmospheric exposure is the most common environment for hot-dip galvanized coatings, but it is also used to protect steel submerged in water, embedded in soil or concrete, and various other environments. Some design plans, such as connecting hot-dip galvanized steel to other dissimilar metals, can impact its longevity. Therefore, engineers, architects, and other designers should be aware of the corrosion variables that affect hot-dip galvanized steel in the proposed service environment. For more information on hot-dip galvanized steel's longevity, please see the AGA's publication, *Performance of Hot-Dip Galvanized Steel Products*.

## SUMMARY

Hot-dip galvanizing is a proven corrosion protection system that transcends time. Following the best design practices for items to be hot-dip galvanized facilitates the development of a high-quality coating and helps ensure the durability and longevity of the steel. Developing the built environment with long lasting materials such as hot-dip galvanized steel sustains the environment and maintains your quality of life.



## ASTM INTERNATIONAL

### RELATED SPECIFICATIONS

ASTM A36	<i>Specification for Carbon Structural Steel</i>
ASTM A123	<i>Specification for Zinc (Hot-Dip Galvanized) Coatings on Iron and Steel Products</i>
ASTM A143	<i>Practice for Safeguarding against Embrittlement of Hot-Dip Galvanized Structural Steel Products and Procedure for Detecting Embrittlement</i>
ASTM A153	<i>Specification for Zinc Coating (Hot-Dip) on Iron and Steel Hardware</i>
ASTM A384	<i>Practice for Safeguarding Against Warpage and Distortion during Hot-Dip Galvanizing of Steel Assemblies</i>
ASTM A385	<i>Practice for Providing High Quality Zinc Coatings (Hot-Dip)</i>
ASTM A563	<i>Specification for Carbon and Alloy Steel Nuts</i>
ASTM A572	<i>Specification for High-Strength Low-Alloy Columbium - Vanadium Structural Steel</i>
ASTM A767	<i>Specification for Zinc-Coated (Galvanized) Steel Bars for Concrete Reinforcement</i>
ASTM A780	<i>Practice for Repair of Damaged and Uncoated Areas of Hot-Dip Galvanized Coatings</i>
ASTM B6	<i>Specification for Zinc</i>
ASTM D6386	<i>Practice for Preparation of Zinc (Hot-Dip Galvanized) Coated Iron and Steel Product and Hardware Surfaces for Painting</i>
ASTM D7803	<i>Practice for Preparation of Zinc (Hot-Dip Galvanized) Coated Iron and Steel Product and Hardware Surfaces for Powder Coating</i>
ASTM E376	<i>Practice for Measuring Coating Thickness by Magnetic-Field or Eddy-Current (Electromagnetic) Test Methods</i>

## CANADIAN STANDARDS ASSOCIATION

G40.8	<i>Structural Steel with Improved Resistance to Brittle Fracture</i>
G40.12	<i>General Purpose Structural Steel</i>
G164	<i>Galvanizing of Irregularly Shaped Articles</i>

## OTHER RECOMMENDED/RELATED AGA PUBLICATIONS

*Hot-Dip Galvanizing for Sustainable Design*, American Galvanizers Association; Centennial, CO; 2017

*Hot-Dip Galvanizing for Corrosion Protection, A Specifier's Guide*, American Galvanizers Association; Centennial, CO; 2012

*Recommended Details for Galvanized Structures*, American Galvanizers Association; Centennial, CO; 2012

*The Inspection of Hot-Dip Galvanized Steel Products*, American Galvanizers Association; Centennial, CO; 2016

*Hot-Dip Galvanized Fasteners*, American Galvanizers Association; Centennial, CO; 2009

*Welding & Hot-Dip Galvanizing*, American Galvanizers Association; Centennial, CO; 2009

*Performance of Hot-Dip Galvanized Steel Products*, American Galvanizers Association; Centennial, CO; 2010





[GALVANIZEIT.ORG](http://GALVANIZEIT.ORG)

